

MOS SERIES

IMPORTANT SAFEGUARDS

When using electrical equipment, basic safety precautions should always be followed, including the following:

THIS PRODUCT MUST BE INSTALLED IN ACCORDANCE WITH THE APPLICABLE INSTALLATION CODE BY A PERSON FAMILIAR WITH THE CONSTRUCTION AND OPERATION OF THE PRODUCT AND THE HAZARDS INVOLVED. DISCONNECT POWER TO ALL CIRCUITS BEFORE WIRING FIXTURE. INSTALL IN ACCORDANCE WITH ALL NATIONAL, STATE, AND LOCAL CODES. DO NOT CONNECT TO AN UNGROUNDED SUPPLY. READ ALL FIXTURE MARKINGS AND LABELS TO ENSURE CORRECT INSTALLATION OF FIXTURE. SUPPLEMENTAL INSTRUCTIONS MAY BE LOCATED ON THE FIXTURE, IN ADDITION TO THIS INSTRUCTION SHEET, REGARDING ORIENTATION, OR MOUNTING RESTRICTIONS.



INSTALLATION INSTRUCTIONS

SAVE THESE INSTRUCTIONS

I. Mounting Instructions

1. Read all fixture markings and labels to insure correct installation of the fixture. Additional information may be located on the fixture, separate from this instruction sheet, regarding orientation and mounting restrictions.
2. For Peace of Mind Warranty, fixture must be mounted to surface with at least 4 fasteners (4 point mounting). Attachment only to the electrical box will not insure proper fixture performance.
3. Disconnect power to circuit before wiring fixture.
4. Remove lens from housing (9500 screwdriver, ordered separately, required for fixtures supplied with Torx® fasteners); Remove (4) 5/16" hex head screws to remove reflector/wireway cover (see Figure 1).
5. (see Figure 2 for mounting holes) Using 1/4-20 fasteners and anchors appropriate for the mounting surface (not supplied), mount fixture housing.

NOTE: Do not touch reflective surface as it could cause damage.

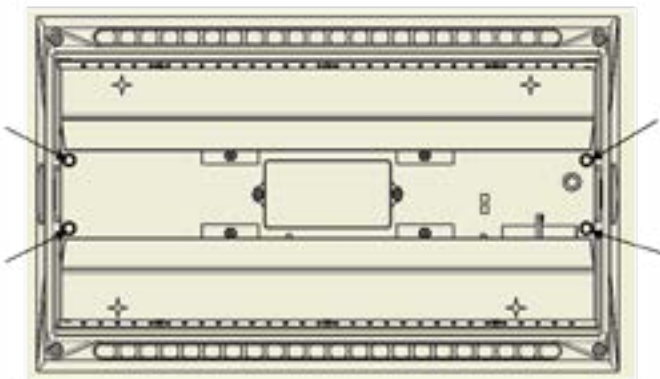

Figure 1 - Remove reflector/wireway cover

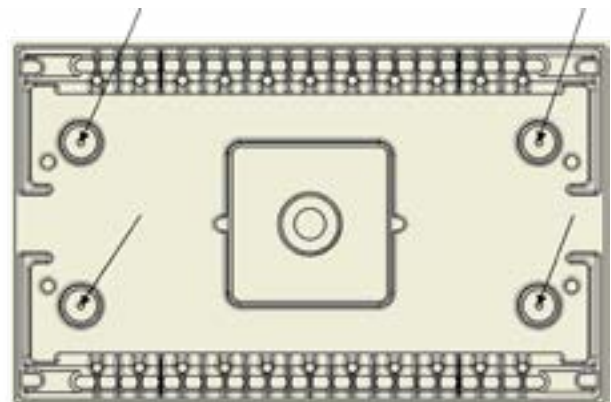
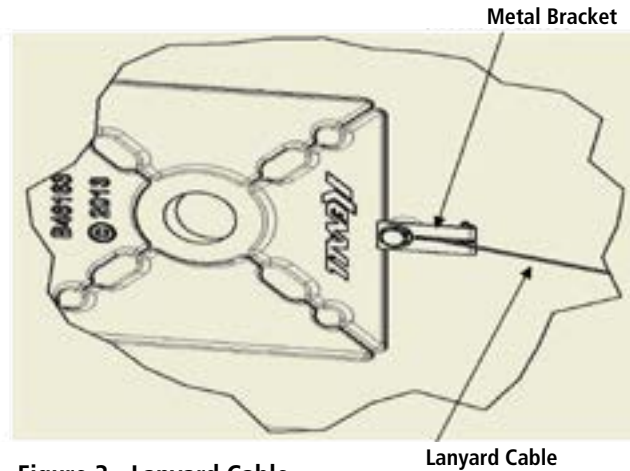

Figure 2 - Mounting Holes (4)



6. Connect fixture connector leads to power supply leads using connectors suitable for the gauge and number of wires being used (not included). Connections are to be made in the fixture. Black fixture lead connects to the supply conductor, white fixture lead connects to the neutral supply conductor, and the grounding wire must be connected to a suitable ground. Slide lanyard cable into slot on metal bracket. (see Figure 3) Connect LED module and power connectors.
7. Reassemble reflector/wireway cover. Make sure reflector is pushed down at locations indicated ( Figure 1). Ensure flexible reflector clears LEDs upon installation. Note that reflector is susceptible to dirt accumulation from hands/fingers Reassemble lens to housing.



## II. Sensor Instructions - Technical Specifications

Product Type: Microwave Motion Sensor

Operation Voltage: 120-277VAC 50Hz/60Hz

HF System: 5.8 GHz CW radar

Transmission Power: <0.2mW

Rated Load: 277V~800W (Capacitive load)  
120V~400W (Capacitive load)

Detection Angle: 30~150°C

Power Consumption: <1W

Detection Range: 12~18 meters in diameter, adjustable

Time Setting: 5s~30min.

Light Control: 2~50 LUX, Disable

Stand-by Period: 0s, 10s-1h, +∞

Stand-by Dimming Level: 10%~50%

Mounting: Indoors, Ceiling and Walling

Working Temperature: -35~+70°C

The sensor is an active motion detector; it emits a high-frequency electromagnetic wave 5.8GHz and receives its echo. The sensor detects the change in echo from movement in its detection zone. A microprocessor then triggers the switchlight ON command. Detection is possible through doors, panels of glass and thin walls.

NOTE: The high-frequency output of this sensor is <0.2mW; approximately just 1% of the transmission power of a mobile telephone or the output of a microwave oven.



### III. Sensor Instructions

- If applicable, adjust Hytronik sensor per Sensor Instructions.
- Detection Range: This determines the effective range of the motion detector and is set by DIP switches at the sensor itself, refer to figure. Note that reducing the sensitivity will also narrow the detection range.

The following Settings are available:

- I - Detection Range 100% (Default)
- II - Detection Range 75%
- III - Detection Range 50%
- IV - Detection Range 10%

	1	2	
I	●	●	100%
II	●	○	75%
III	○	●	50%
IV	○	○	10%



- Hold Time: This determines the time the fitting remains 100% level on motion detection and is set with DIP switches at the sensor itself, refer to figure. The following settings are available:

- I - 5 Seconds (Default)
- II - 30 Seconds
- III - 1 Minute
- IV - 5 Minutes
- V - 10 Minutes
- VI - 20 Minutes
- VII - 30 Minutes

	1	2	3	
I	●	●	●	5s
II	●	●	○	30s
III	●	○	●	1min
IV	●	○	○	5min
V	○	●	●	10min
VI	○	●	○	20min
VII	○	○	○	30min



- Daylight Sensor: This setting holds off the 100% should there be sufficient daylight and is set with DIP switches at the sensor itself, refer to figure.. The following settings are available:

- I - Disable (Default)
- II - 50 Lux
- III - 10 Lux
- IV - 2 Lux

	1	2	
I	●	●	Disable
II	●	○	50Lux
III	○	●	10Lux
IV	○	○	2Lux



- Stand-By Period (Corridor Function): This is the time period you would like to keep the low light output level before it is completely switched off in the long absence of people. The following settings are available:

- I - 0 Seconds - On/Off control
- II - 10 Seconds
- III - 1 Minute
- IV - 5 Minutes
- V - 10 Minutes
- VI - 30 Minutes
- VII - 1 Hour
- VIII - 2 Steps of dimming control, fixture never switch off (Default)

	1	2	3	
I	●	●	●	0s
II	●	●	○	10s
III	●	○	●	1min
IV	●	○	○	5min
V	○	●	●	10min
VI	○	●	○	30min
VII	○	○	●	1hr
VIII	○	○	○	+∞



6. Stand-By Dimming Level: This is the dimmed low light output level you would like to have after the hold-time in the absence of people.

- I - Dimmed low light output level 10% (default)
- II - Dimmed low light output level 20%
- III - Dimmed low light output level 30%
- IV - Dimmed low light output level 50%

	1	2	
I	●	●	10%
II	●	○	20%
III	○	●	30%
IV	○	○	50%



## IV. Sensor Instructions- Functions

### 1. 100H burn-in mode for fluorescent lamp

With simple operation, rapidly turn off/on the fixture 3 cycles within 3 sec. (The green LED on the sensor flashes and the fixture blinks 3 times to indicate the success of setup), lamp will be 100% on for 100 hours and then automatically goes to sensor mode after 100 hours. This is crucial to secure the lifetime of fluorescent lamp when new fixture is installed, or old lamp is replaced. This 100h burn-in feature can be cancelled by turning off/on the fixture 1 cycle within 1 sec.

### 2. Ambient Daylight Threshold

With simple operation, rapidly turn off/on the fixture 2 cycles within 2 sec:

- A. The green LED on the sensor flashes slowly for 5 seconds, meanwhile the fixture blinks twice.
- B. The daylight sensor measures and remembers the surrounding lux for 1 sec.
- C. The fixture and green LED is on for 10s to indicate the success of learning.

- \* This feature enables the fixture to function well in any real application circumstance, where the daylight penetrated into the fixture may vary a lot.
- \* The latest surrounding lux value overwrites previous lux value learned.
- \* Both the setting on DIP switch and the learned ambient lux threshold can overwrite each other. The latest action stays in validity.

### 3. Zero-cross relay operation

Designed in the software, the sensor switches on/off the load right on the zero-cross point, to ensure the min. current passing through the relay contact point, and enable the max. load and life-time of the relay.

### 4. Loop-in and Loop-out

Double L N terminal makes it easy for wire loop-in and loop-out, saves the cost of terminal block and assembly time.

- \* Motion sensor overwrites daylight sensor, meaning the daylight sensor starts to check the ambient natural light only when the lamp is switch off (motion hold-time elapsed).
- \* This 1-10v output is isolated, SELV output.



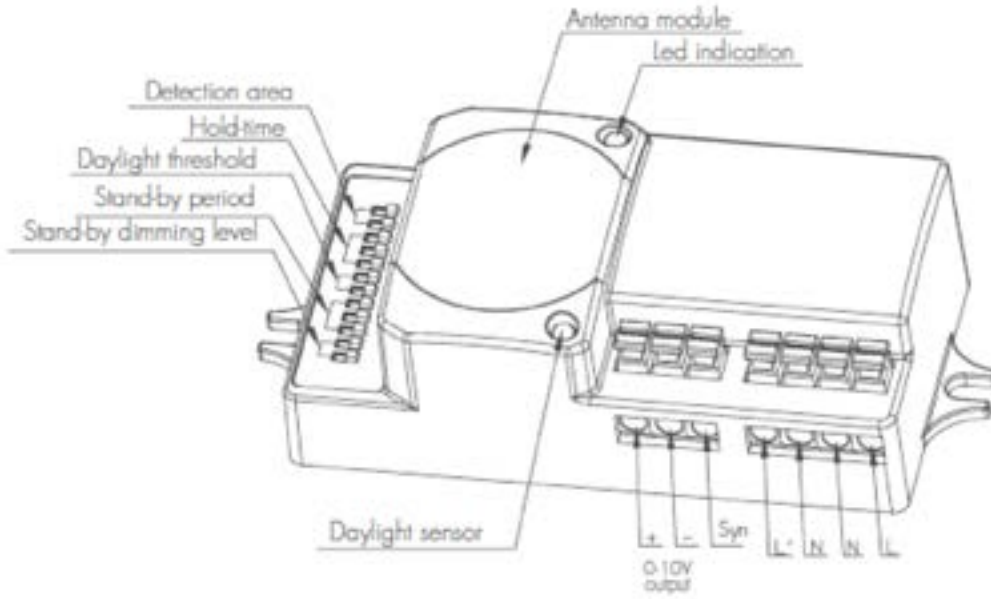

## Sensor Coverage

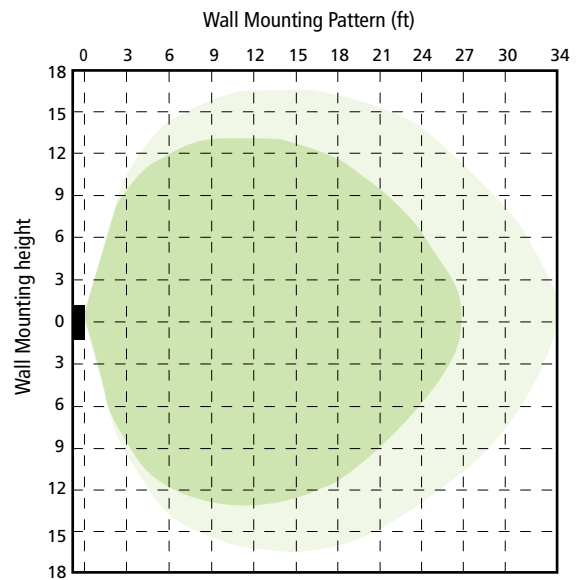
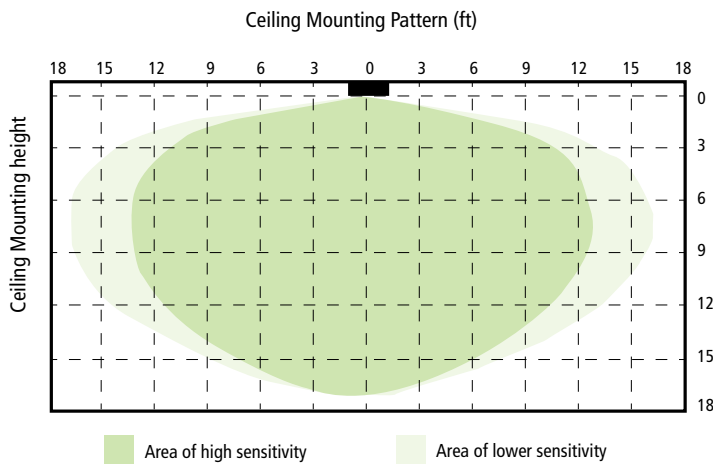

www.kenall.com | P: 800-4-Kenall | F: 262-891-9701 | 10200 55th Street Kenosha, Wisconsin 53144, USA

This product complies with the Buy American Act: manufactured in the United States with more than 50% of the component cost of US origin. It may be covered by patents found at [www.kenall.com/patents](http://www.kenall.com/patents). Content of specification sheets is subject to change; please consult [www.kenall.com](http://www.kenall.com) for current product details. ©2019 Kenall Mfg. Co.

A brand of **legrand**

MOS\_F-5223\_090418

## V. Sensor Instructions- Troubleshooting

Malfunction Cause Remedy	Cause	Remedy
The load will not work	Incorrect light-control setting selected	Adjust setting
	Load Faulty	Replace load
	Main switch OFF	Switch ON
The load is always on	Continuous movement in the detection zone	Check zone setting
The load is on without any identifiable movement	The sensor is not mounted for reliably detecting movement	Securely mount enclosure
	Movement occurred, but not identified by the sensor (movement behind wall, movement of small object in immediate lamp vicinity etc.)	Check zone setting
The load will not work despite movement	Rapid movements are being suppressed to minimize malfunctioning or the detection radius is too small	Check zone setting

### CUSTOMER SERVICE

For technical assistance, call 1-800-4KENALL (1-800-453-6255).

### WARRANTY

For warranty information visit [www.kenall.com/Resources/Certified-Performance-Warranties](http://www.kenall.com/Resources/Certified-Performance-Warranties)

